

Casa
Terry

Sequoia

Ardesia

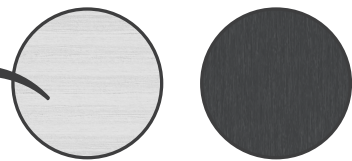
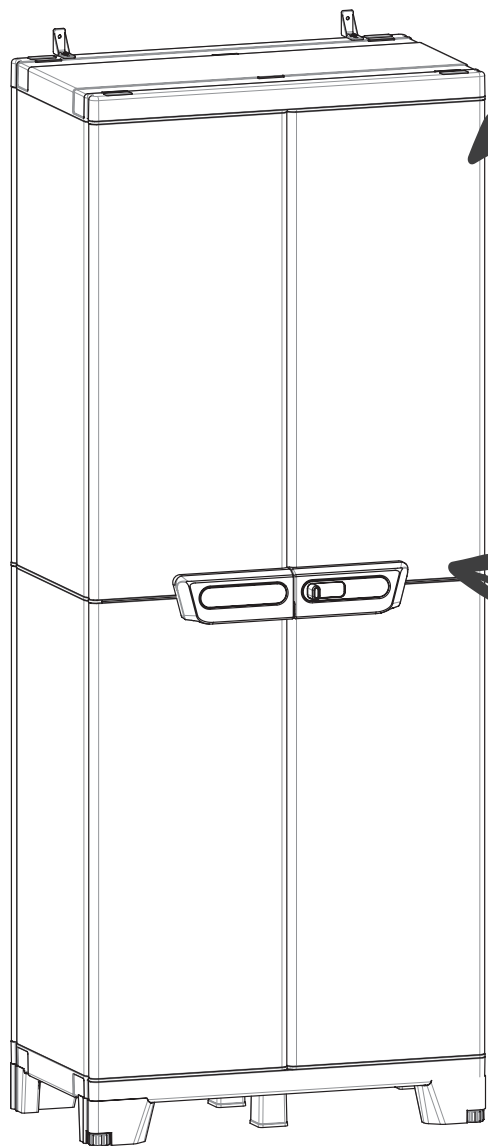

Finitura effetto legno/pietra
Wood/stone effect

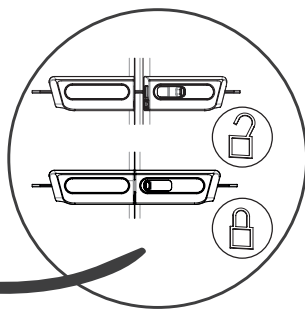

Chiusura anti-vento
Wind-resistant locking system

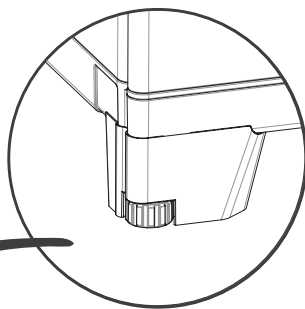

Piedini regolabili in altezza
Adjustable feet

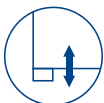
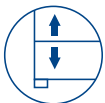

CAB 102A ARDESIA

Code: 1003203
Ean: 8005646032035
Item (LxPxH): 102x39x172
Pack (LxPxH): 102,5X39,5X50,5
Pcs/pack: 1
Pallet: 100x120x230
Pcs/pallet: 12



CAB 102B ARDESIA

Code: 1003204
Ean: 8005646032042
Item (LxPxH): 102x39x93,5
Pack (LxPxH): 102,5X40X27,2
Pcs/pack: 1
Pallet: 100x120x230
Pcs/pallet: 24



CAB 2680 ARDESIA

Code: 1003201
Ean: 8005646032011
Item (LxPxH): 68x39x172
Pack (LxPxH): 80X41X42,5
Pcs/pack: 1
Pallet: 80x120x230
Pcs/pallet: 15

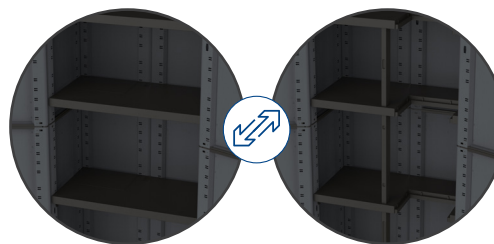

CAB 680 ARDESIA

Code: 1003202
Ean: 8005646032028
Item (LxPxH): 68x39x93,5
Pack (LxPxH): 80X40X27,5
Pcs/pack: 1
Pallet: 80x120x230
Pcs/pallet: 24



Ardesia

CAB 102A SEQUIOA

Code: 1003207
Ean: 8005646032073
Item (LxPxH): 102x39x172
Pack (LxPxH): 102,5X39,5X50,5
Pcs/pack: 1
Pallet: 100x120x230
Pcs/pallet: 12



CAB 102B SEQUIOA

Code: 1003208
Ean: 8005646032080
Item (LxPxH): 102x39x93,5
Pack (LxPxH): 102,5X40X27,2
Pcs/pack: 1
Pallet: 100x120x230
Pcs/pallet: 24

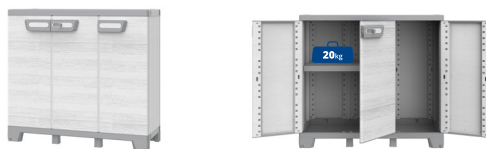

CAB 2680 SEQUIOA

Code: 1003205
Ean: 8005646032059
Item (LxPxH): 68x39x172
Pack (LxPxH): 80x41X42,5
Pcs/pack: 1
Pallet: 80x120x230
Pcs/pallet: 15

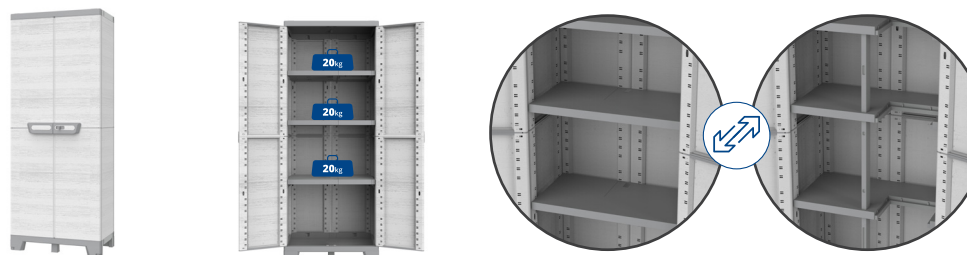

CAB 680 SEQUIOA

Code: 1003206
Ean: 8005646032066
Item (LxPxH): 68x39x93,5
Pack (LxPxH): 80x40X27,5
Pcs/pack: 1
Pallet: 80x120x230
Pcs/pallet: 24



Sequoia



Terry Store-Age spa
V.le De Gasperi, 66 - Bareggio (MI)

www.terry.it